

4G CAT M1 GPS TRACKER

For Vehicle

<GPS+GSM/GPRS/LTE+SMS+Temperature/SOS>

User Manual



MODEL:TK319-L



Professional Tracking System

CATALOG

| | |
|-------------------------------------|----|
| I. Product Features..... | 5 |
| II. Components and Accessories..... | 7 |
| III. SIM card Installation..... | 9 |
| IV. device Installation..... | 10 |
| 4.1 Install device..... | 10 |
| 4.2 device wiring definition..... | 12 |
| 4.3 Relay wiring..... | 14 |
| V. Power On / Off..... | 15 |
| 5.1 Power on..... | 15 |
| 5.2 LED Indicators..... | 15 |
| 5.3 Power off..... | 16 |
| VI. Inquiry/Monitoring/Cut Oil..... | 16 |
| 6.1 Inquiry by service platform.. | 16 |
| 6.2 Inquiry by SMS..... | 17 |
| 6.3 Cut Oil /Restore..... | 17 |
| VII. device Alarm..... | 17 |
| 7.1 Temperature Alarm..... | 17 |

| | | |
|-------|---------------------------------------|----|
| 7.2 | Vibration Alarm..... | 18 |
| 7.3 | Collision / falling Alarm..... | 18 |
| 7.4 | Speed Alarm..... | 18 |
| 7.5 | Shift Alarm..... | 19 |
| 7.6 | Geo-fence Alarm..... | 19 |
| 7.7 | Power disconnect Alarm..... | 19 |
| 7.8 | Low battery Alarm..... | 19 |
| VIII. | device Setting..... | 20 |
| IX. | Trouble shooting..... | 20 |
| 9.1 | Cannot connect platform..... | 20 |
| 9.2 | Offline status..... | 20 |
| 9.3 | No positioned..... | 21 |
| 9.4 | Position drift..... | 22 |
| 9.5 | Commands receiving abnormally..... | 22 |
| X. | Warranty Rules..... | 22 |
| 10.1 | Special statement..... | 22 |
| 10.2 | Warranty period..... | 23 |
| 10.3 | After sales..... | 23 |

Welcome to use our device , please read this manual carefully to install and operate device exactly. This user manual is for reference only. If some contents and operation steps are inconsistent with those for the actual product, the latter will prevail.

With TK319-L GPS Tracker, we can monitor your vehicle by GPS satellite positioning system, temperature detection unit, GPRS/LTE CAT M1 communication and Internet, a real-time remote location and temperature monitoring and control of vehicles can be achieved through a powerful service platform. It plays a significant role in logistics and cold chain, helping customers to achieve transparent management, reduce costs, ensure safety, and improve efficiency.

I. Product Features

- Supports GSM/LTE CAT M1.
- Super Wide Input Voltage: 7-72V DC.
- GPS precise positioning, Support A-GPS, uploaded by LTE/GPRS regularly, real-time tracking and history track playback.
- ACC status detection
- Support SOS, Temperature, External battery, GPIO(Hardware customization, Choose one of the four)
- Serial port, also can be GPIO port(Firmware Customization).
- Built-in battery, power disconnect alarm & low battery alarm.
- Built-in G-sensor ,vibration, collision and falling alarm.
- GEO-fence alarm, speed & shift alarm.
- Relay to cut engine, auto cut engine when over speed and recover when normal speed.
- EELINK protocol 2.0, Firmware OTA
- Water proof level IP65

Basic Specifications

| | |
|---------------------|--|
| Voltage | 12/ 24/ 36/ 48/ 60/ 72 VDC |
| Work Current | GPRS(245-265mA); LTE(260mA) |
| Standby Current | IDLE(2mA@12V) |
| GPS Accuracy | 5-15m |
| LBS Accuracy | >100m |
| GPS Band | 1575MHz |
| GSM Band | 850/900/1800/1900MHz |
| LTE Band | Global bands(1,2,3,4,5,8,12,13,17,18,1 9,20,25,26,28 and 39) |
| Temperature-Sensor | Accuracy $\pm 0.5^{\circ}\text{C}$ |
| Temperature-Sensor | Arrange $-30^{\circ}\text{C}\sim 80^{\circ}\text{C}$ |
| Working Temperature | Arrange $-20^{\circ}\text{C}\sim 75^{\circ}\text{C}$ |
| Hot/warm/cold Start | <3s, <15s, <60s |
| Battery Capacity | 140mAh |
| Dimensions (mm) | 89(L)X 37(W) X 12(H) |
| Work Humidity | 20%~80%RH |
| Net Weight | 32g |

II. Components and Accessories

■ Components

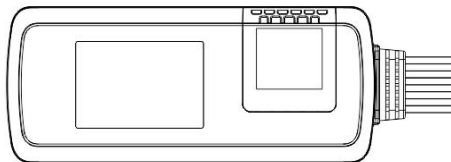

-Top Front-
(Towards sky)

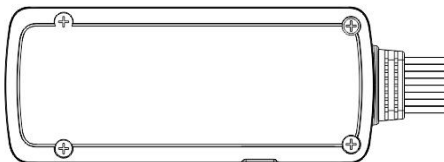

-Bottom -

■ Accessories



Power Cable(Default)



Relay(Optional)



Temperature Sensor(Optional)



SOS(Default Optional)



External Battery(Optional)

Relay for remotely cut engine, Temperature sensor used for monitoring temperature, SOS button used for help, External battery used for power supplier, (Temperature sensor, SOS button, External battery can be only chose one of the three)

Please note that device should be matched with accessories to realize these functions.

III. SIM Card Installation

Open the packing case, check if device is OK and accessories are intact,

You need a suitable SIM card for using device, contact your dealer if any question;

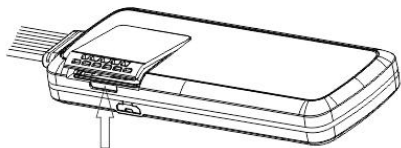

Open SIM Card cover

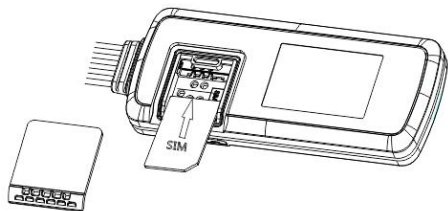

Put SIM Card and waterproof rubber

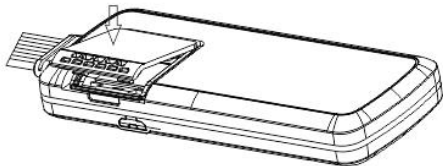

Press cover and close

Note:

- Please cut off the power before installing or uninstalling SIM card.
- SIM card should have GPRS/LTE function, open it's network through operator.
- SIM card should open Caller Identification function for telephone querying.
- If you enable the PIN code of the SIM card, please use your mobile phone to disable the PIN code.
- Please make sure SIM card has sufficient balance.

IV. Device Installation

4.1 Install device

4.1.1 Please install device concealed by professional person

Please make sure to install device with this side upward, and use wide strong double-sided adhesive sponge to fix it.

4.1.2 Installation Notice

- Hide device properly inside the car body in order to avoid damages.
- Keep device away from RF emission sources such as backing radar, car burglar alarm and other vehicle mounted communication devices.
- Suggest to use wide strong double-sided adhesive sponge to fix it, or use cable ties and other liable methods to fix it.
- Device Built-in GSM/LTE antenna and GPS antenna, Please ensure that signal receiving side is facing up(towards the sky) when doing installation, without any metal material covered on the top.It may weaken signal and results in not work properly
- Temperature sensor should be placed in the space that needs to be detected.

4.2 device wiring definition

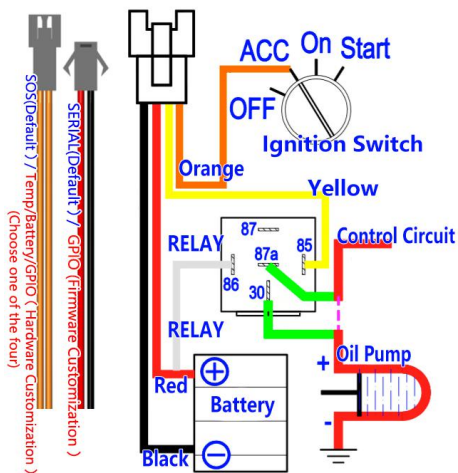

Total schematic wiring device

4.2.1 Power cables and interface

The standard input voltage of device is 7V-72VDC, so please choose the our original power cables, the red cable is positive and the black cable is negative; Please ground negative pole separately or ground it to ground connection, not to any other ground.





Connect the ACC cable (orange cable) to ACC switch of the vehicle, the position server will get

ignition status of vehicle; the ACC cable can also be connected directly to the positive pole of the vehicle power, then the position server think that the vehicle is always ignited.

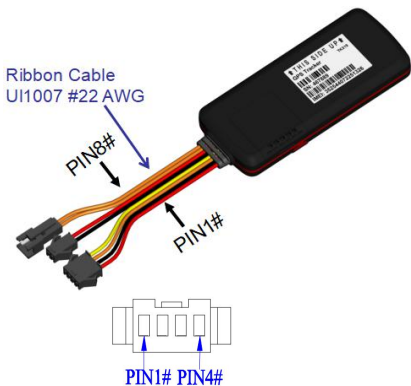
Connect the 4# cable (yellow cable) to the 85 device(with small yellow cable) of the relay. Use cable ties to fix the relay to waterproof place, or use plastic bags cover the relay.

Connect Temperature sensor with PIN7 & PIN8.



| | | |
|----|----------------|---|
| 1# | Power +, Red |  |
| 2# | Power -, Black |  |
| 3# | ACC, Orange |  |
| 4# | Relay, Yellow |  |

2.54 2P SM Male



2.54 2P SM Female

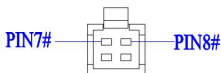

| | | |
|----|-------------|-------|
| 5# | Serial/GPIO | Black |
| 6# | Serial/GPIO | Red |

| | | |
|----|-----------------------|--------|
| 7# | SOS/Temp/Battery/GPIO | Orange |
| 8# | SOS/Temp/Battery/GPIO | Orange |

4.3 Relay wiring

Relay wiring diagram shows how to wire the relay to control the fuel pump:

4.3.1 Connect the 86 port to the positive pole of the vehicle power (+12V/+24V), connect the 85 port to the 4# cable of device.

4.3.2 Cut off the positive pole of the fuel pump, next serial connect the positive pole to the 87a port of the relay, and connect another pole to 30 port, showing as in the figure.



Bottom of the relay Wiring Diagram

Notice: Be sure the voltage of the vehicle power should match up to the working voltage of relay, or relay will be damaged.

V. Power On / Off

5.1 Power on

Power on: insert a valid SIM card and wire all the cables, device will power on.

5.2 LED Indicators

The red LED flickers fast when device is searching for GSM/LTE network, it flickers intermittently when device has registered the GSM/LTE network successfully.

The blue LED flickers fast when device is searching for the GPS satellite signal, it flickers intermittently when device has searched the satellites and can be positioned.

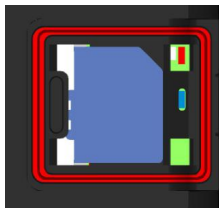

Red LED / GSM/LTE

Blue LED / GPS

1. Red LED(indicates GSM/LTE working state)

| | |
|---------------|-------------------------------|
| Fast blinking | Searching for GSM/LTE network |
| Slow blinking | GSM/LTE works normally |

2. Blue LED(indicates GPS signal state)

| | |
|---------------|--------------------------|
| Fast blinking | Searching GPS Satellites |
| Slow blinking | GPS works normally |

5.3 Power off

Disconnect the external power and take off SIM card, after a while device will shut down.

VI. Inquiry/Monitoring/Cut Oil

6.1 Inquiry by service platform

6.1.1 Web Browser platform

Login the service platform and enter your ID and password to check the position of device. Please ask your dealer for the WWW address of the position service platform.

6.2.2 Smart phone applications

You can use a smart phone to check device's position. We have prepare for you the Android client (Android), Apple clients (IOS), please check with

your dealer to get installation package.

6.2 Inquiry by SMS

You can write a positioning SMS sending to device to inquiry position, device will reply position SMS or map link. The SMS commands please refer to the Operation Commands

6.3 Cut Engine/Restore

6.3.1 Cut off oil circuits

Server(GPRS/LTE) or Manager number (SMS) can send cut-fuel-circuit commands to device when needed. Engine can not start, vehicle will be locked. To make sure safety of vehicle, fuel of vehicle Can be cut off only if device has been positioned by GPS and speed of vehicle is less than 20KM/h or vehicle is static.

6.3.2 Recover oil circuits

Server(GPRS/LTE) or Manager number (SMS) can send recover-fuel-circuit commands to device when needed, device will recover fuel circuits of vehicle.

VII. Device Alarm

7.1 Temperature Alarm

Conditions: When Temperature exceed set range

Note: You need to set Temperature range value & time.

Or SOS Alarm

Conditions: When SOS button is long pressed for 3 seconds.

Note: SOS button must be installed (optional accessory), and SOS administrator number must be set. When the SOS alarm occurs, terminal will dial the set SOS administrator number 3 times until get through.

Note: When above alarm occurs, Device will send alarm to service platform, meanwhile send a SMS message to administrator number if this number was set.

7.2 Vibration Alarm

Conditions: When the Vehicle Vibration occurs.

Note: You need to set vibration sensitivity and time, there is an alarm switch.

7.3 Collision / falling Alarm

Conditions: When Vehicle Collision or falling occurs.

7.4 Speed Alarm/Cut engine when over speed

Alarm Conditions: When vehicle speed over and below the setting speed.

Cut engine Conditions: Cut engine when over setting speed (Restore engine after returning

setting speed)

Note: You need to set the low speed limit and the high speed, and an over-speed setting to cut engine

7.5 Shift Alarm

Conditions: When vehicle occur a setting shift in the Flameout status.

Note: Only valid in flameout state and vehicle occur a setting shift distance.

7.6 Geo-fence Alarm

Conditions: when the vehicle entry / exit / across the Geo-fence.

Note: You need to set the conditions of crossing fence, fence types and so on.

7.7 Power Disconnect Alarm

Conditions: When the device is disconnected from external Power.

7.8 Low Battery Alarm

Conditions: When the device is disconnected from external Power and built-in battery power falls below a certain value .

Note: Alarm parameters must be set before work in 7.1, 7.2, 7.4,7.5&7.6, Please refer to the **<Operation Commands>**

Note: When above alarm occurs, device will send alarm to service platform, meanwhile send a SMS message to the administrator number if the number is set.

VIII. Device Setting

Please refer to <**Operation Commands**>

IX. Trouble shooting

9.1 Cannot connect platform

device is never online on the position server when installed at the first time. Please check device:

- 1) If power cables are wired correctly? Pay attention to not connect them to controlling cables of vehicle.
- 2) If SIM card is installed correctly? Please refer to the installation instructions.
- 3) Check the status of LED indicators. If device is OK, red LED and blue LED will intermittently flick.
- 4) Inquiry parameters of device via commands and check replied parameters.

9.2 Offline status

First check if LED indicators are OK, if cannot

check them, you can check SIM card following next steps:

- 1) call SIM card of device and check if you can hear connecting ring.
- 2) Check if vehicle is in the area where there is no GSM/LTE signal.
- 3) Check if one device or all devices are offline in the area . If all devices are offline, you should ask operator If network is OK.
- 4) Check if SIM card has enough balance.
- 5) If device becomes offline on the last day of one month, please check GPRS is closed or not.
- 6) Inquiry parameters of device via commands and check replied parameters.

9.3 No positioned

If the GPS is active, but device cannot be positioned for long time, please check device:

- 1) If the vehicle is in the place where there is no GPS signal.
- 2) The upside of device should be installed with face toward the sky.
- 3) The GSM/LTE and GPS signal may be weakened if device is installed in the place with

electromagnetic wave absorption material(such as metal blocks), special attention should be paid if there is metal thermal insulation layer or heating layer on the front windshield, so that the position accuracy will decline, and the severe ones will not be positioned.

9.4 Position drift

Serious position drift will be found in places where GPS signal is poor. Please drive the vehicle to the open places.

9.5 Commands receiving abnormally

- 1) Check the commands format.
- 2) Check if the vehicle is in the places where there is GSM signal.
- 3) Check if the SIM card is properly installed.

X. Warranty Rules

10.1 Special statement

- 1) Technology change without notice.
- 2) If the color and appearance are inconsistent with those for the actual product, the latter will prevail.
- 3) Warranty card is only valid for devices with the

following IMEI.

4) Please take care of the warranty card and show it with the original purchase receipts when enjoying the warranty service.

10.2 Warranty period

Since the date of purchase, passive waste host has one year warranty.

10.3 After sales

Any of the following circumstances not covered by the warranty, but may be appropriate to pay repair:

- 1) More than the warranty period.
- 2) Unauthorized removal or repair damaged.
- 3) Damage caused by improper installation, use, maintenance, custody.
- 4) IMEI label is torn or Obscure.
- 5) Warranty certificate and product models do not match or warranty certificate be altered.
- 6) Damage caused by force majeure.